

53112610	DATA SHEET	
Valid from: 24.01.2025	SKINTOP® MS-SC-M / MS-SC-M-XL	

The SKINTOP® MS-SC-M / MS-SC-M-XL is a nickel-plated brass cable gland especially designed for copper-screened cables and is used to achieve a low-resistance screen contact, strain relief and high protection class.
The SKINTOP® MS-SC-M / MS-SC-M-XL is not qualified for cases twisting a gland after inserting the cable (e.g. circular connectors).



Components:

Gland body	Brass, nickel-plated Lead free Brass, nickel-plated
Cap nut	Brass, nickel-plated Lead free Brass, nickel plated
Insert with lamellar cage	Polyamide, V2 acc. to UL94
Sealing ring	CR (ozone and UV- resistant)
Contact spring	CuBe, tin-plated
O-ring	NBR (ozone and UV- resistant)

Technical features:

Connecting thread	M12x1,5 up to M50x1,5 acc. to EN 60423
Protection class / NEMA Typ Rating	IP66 acc. to DIN EN 60529 IP68 - 10 bar acc. to DIN EN 60529 IP69 acc. to DIN EN 60529 Type 1, Type 4X, Type 6 and Type 12 acc. to UL 50E, CSA C22.2 No. 94.2-15
Temperature range	Dynamic -25 °C up to +100 °C Static -40 °C up to +100 °C
Transfer impedance	≤ 10 mOhm
Screening attenuation	up to 98dB
Corrosion protection	Salt spray test (168 H. / 35°C) acc. to DIN EN ISO 9227

Approvals:



UL File Nr. 79903
(Test in acc. to UL514B)

Norm references:



Creator: VACH1/PDP Released: DAMU1/PDP	Document: DB53112610EN Version: 23	Page 1 of 2
---	---------------------------------------	-------------

53112610	DATA SHEET	
Valid from: 24.01.2025	SKINTOP® MS-SC-M / MS-SC-M-XL	

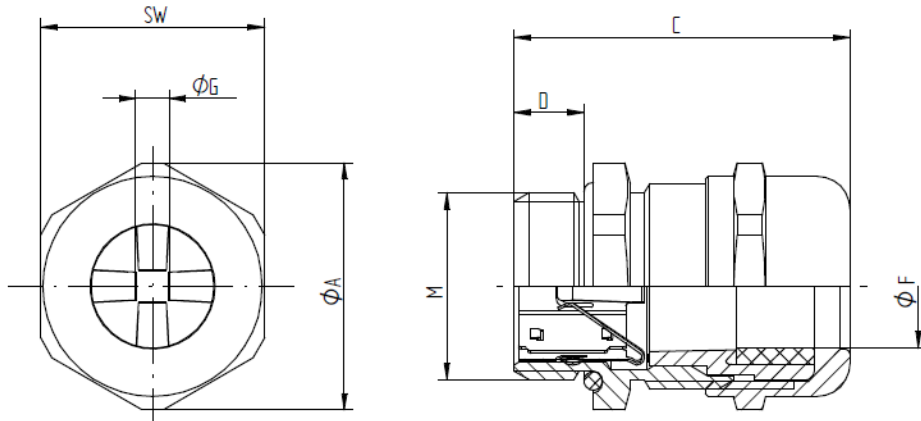

SKINTOP® MS-SC-M

M	SW [mm]	Ø A [mm]	C max. [mm]	D [mm]	Ø F [mm] Clamping range	Ø G [mm]	O-Ring [mm]	Art. No.	
								Brass	Lead free Brass
M12x1,5	16	17,6	26,5	6,5	3,5-7	1,0	9x2	53112610	53112610LF
M16x1,5	20	22,0	33,0	7,0	4,5-10	4,0	13x2	53112620	53112620LF
M20x1,5	24	26,4	37,0	8,0	7-13	5,0	17x2	53112630	53112630LF
M25x1,5	29	31,9	38,5	8,0	9-17	7,5	22x2	53112640	53112640LF
M32x1,5	36	39,6	45,5	9,0	11-21	9,0	28x2	53112650	53112650LF
M40x1,5	45	49,5	48,0	9,0	19-28	15,0	36x2	53112660	53112660LF
M50x1,5	54	59,0	55,5	10,0	27-35	21,0	46x2	53112670	53112670LF

SKINTOP® MS-SC-M-XL

M	SW [mm]	Ø A [mm]	C max. [mm]	D [mm]	Ø F [mm] Clamping range	Ø G [mm]	O-Ring [mm]	Art. No. Brass
M12x1,5	16	17,6	32,0	12	3,5-7	1,0	9x2	53112615
M16x1,5	20	22,0	38,0	12	4,5-10	4,0	13x2	53112625
M20x1,5	24	26,4	41,0	12	7-13	5,0	17x2	53112635
M25x1,5	29	31,9	42,5	12	9-17	7,5	22x2	53112645
M32x1,5	36	39,6	51,5	15	11-21	9,0	28x2	53112655
M40x1,5	45	49,5	54,0	15	19-28	15,0	36x2	53112665
M50x1,5	54	59,0	60,5	15	27-35	21,0	46x2	53112675

For more information please see our current catalogue. Please do not hesitate to contact our laboratory if there are any questions regarding resistance against aggressive agents and special oil.

Creator: VACH1/PDP Released: DAMU1/PDP	Document: DB53112610EN Version: 23	Page 2 of 2
---	---------------------------------------	-------------